

The invisible hand for more convenient world

Autonics sensors & controllers

Autonics
Sensors & Controllers

Autonics Control Switches / Buzzers / Sockets

Control Switches Buzzers Sockets



Autonics Control Switches,
Feel the difference
in your fingertips

Control Switches

■ Push Button Switches

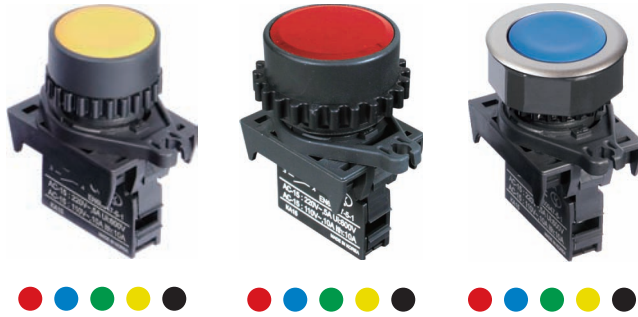

■ Push Button Switches(Illuminated)



■ Selector Switches



■ Double Push Button Switches



■ Start Push Button Switches



■ Emergency Switches



Buzzers / Sockets

■ Pilot Lamps



■ Piezo Buzzers



■ Magnetic Buzzers



■ Sockets

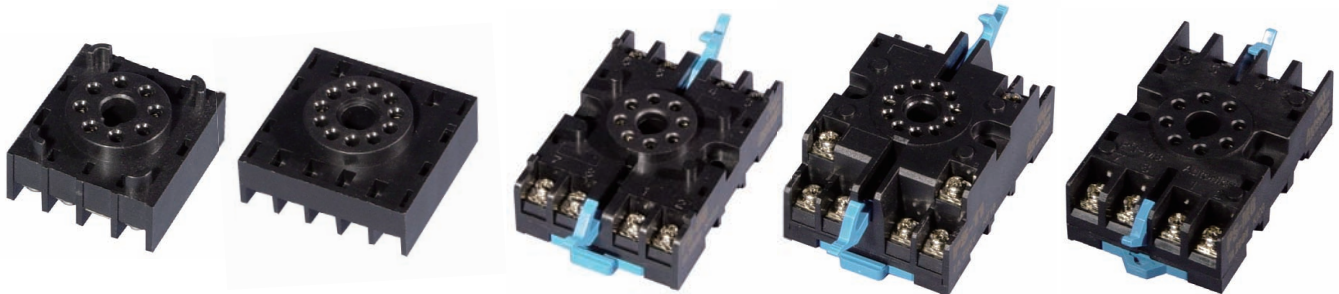

■ Digital Switches



Control Switches

	Non-Flush	Flush	Page
Push Button Switches	Ø22/25		06
	Ø30	Ø30	
Push Button Switches(Illuminated)	Ø22/25		08
		Ø30	
Selector Switches	Short lever	Ø22/25	10
		Ø30	
	Long lever	Ø22/25	
		Ø30	
Double Push Button Switches	Ø22/25		12
Start Push Button Switches	Head D40	Ø22/25	13
Emergency Switches	Head D30L	Ø22/25	14
	Head D30S	Ø22/25	
	Head D40	Ø22/25	
	Head D60	Ø22/25	
Emergency Switches(Illuminated)	Head D40	Ø22/25	16

	DOME TYPE	HORN TYPE	FLAT TYPE	FLAT TYPE (Non-Flush)	Page
Pilot Lamps	Ø22/25	Ø22/25	Ø22/25		17
				Ø30	
Accessories	Switches contact block, Flush mount adaptor, Switch boxes, Emergency switch nameplates, Emergency switch protective shroud, Waterproof cap, Locking ring wrench				20

Buzzers

	Non-Flush	Page
Magnetic Buzzers	Ø22/25	24
Piezo Buzzers	Ø22/25	24
	Ø30	

Sockets

PG-08	PG-11	PS-08	PS-11	PS-M8	25
-------	-------	-------	-------	-------	----

Digital Switches

AD105-I,B	AD604-I,B	AD605-I,B	29
-----------	-----------	-----------	----

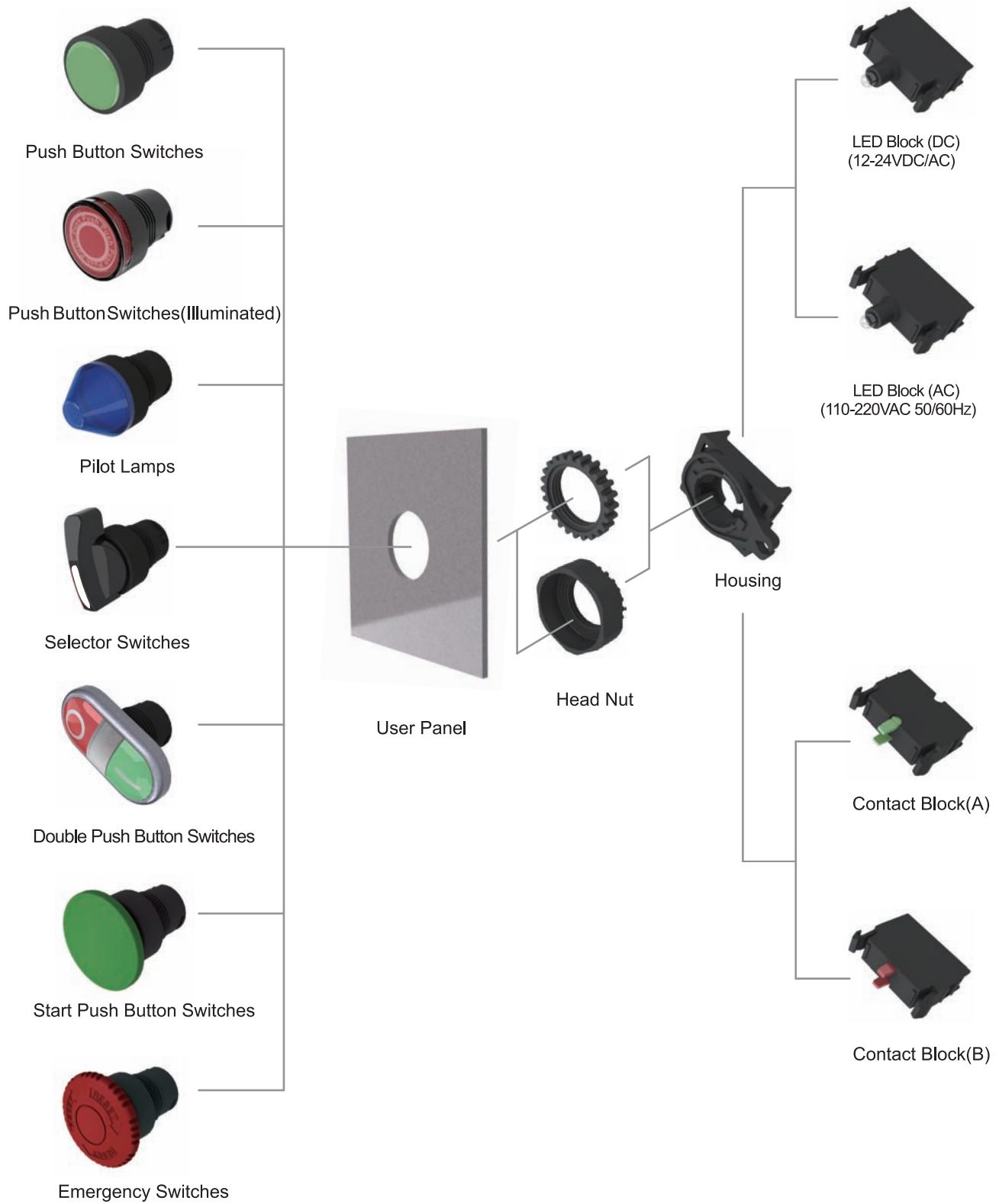

Control Switches



Control Switches Series

Items	Push Button Switches			Push Button Switches(Illuminated)		Double Push Button Switches	Start Push Button Switches
	Non-Flush Ø22 / 25	Non-Flush Ø30	Flush Ø30	Non-Flush Ø22 / 25	Flush Ø30	Non-Flush Ø22 / 25	Non-Flush Ø22 / 25
Mounting Hole Dimension	Ø22 / 25	Ø30	Ø30	Ø22 / 25	Ø30	Ø22 / 25	Ø22 / 25
Model	S2PR-P1	S3PR-P1	S3PF-P1	S2PR-P3	S3PF-P3	S2TR-P3	S2BR-P1
Appearance							
Page	06	07	07	08	08	12	13
Items	Selector Switches, Non-Flush			Selector Switches, Non-Flush			
	Short Lever Ø22 / 25		Long Lever Ø22 / 25	Short Lever Ø30		Long Lever Ø30	
Mounting Hole Dimension	Ø22 / 25		Ø22 / 25	Ø30		Ø30	
Model	S2SR - S3,5,7		S2SR - S4,6,8	S3SF - S3,5,7		S3SF - S4,6,8	
Appearance							
Page	10		10	11		11	
Items	Ø30 Emergency Switches		Ø40 Emergency Switches		Ø60 Emergency Switches		
	Large Head Ø22 / 25	Small Head Ø22 / 25	Non-Illuminated Ø22 / 25	Illuminated Ø22 / 25	Non-Illuminated Ø22 / 25		
Mounting Hole Dimension	Ø22 / 25	Ø22 / 25	Ø22 / 25	Ø22 / 25	Ø22 / 25		
Model	S2ER - E1	S2ER - E2	S2ER - E3	S2ER - E4	S2ER - E5		
Appearance							
Page	14	15	15	16	16		
Items	Dome Type / Horn Type / Flat Type Pilot Lamps						
	Dome Type Ø22 / 25	Horn Type Ø22 / 25	Flat Type Ø22 / 25	Flat Type, Flush Ø30			
Mounting Hole Dimension	Ø22 / 25	Ø22 / 25	Ø22 / 25	Ø30			
Model	L2RR - L1	L2RR - L2	L2RR - L3	L3RF - L3			
Appearance							
Page	17	18	18	19			

Specifications

Mechanical Characteristics	Actuating Travel	5.5mm (0 ~ -0.5)	
	Actuating Force	4.9N (0.5Kgf) (at 1 contact)	
	Shock	Shock Resistance	500m/s ² (50G) in each of x,y,z directions for 3 times
		Mechanical Malfunction	100m/s ² (10G) in each of x,y,z directions for 3 times
	Vibration	Vibration Resistance	1.5mm amplitude at frequency of 10~55Hz(for 1minute) in each of x,y,z directions for 2 hours
Mechanical Malfunction		1.5mm amplitude at frequency of 10~55Hz(for 1minute) in each of x,y,z directions for 10 minutes	
	Mechanical Life Time	Min. 100 thousand (20 times/min)	
Electrical Characteristics	Rated Voltage/Current	110VAC/10A, 250VAC/6A	
	Dielectric Strength	2000VAC 50/60Hz for 1 minute	
	Insulation Resistance	Min.100MΩ (at 500VDC)	
	Contact Resistance	Max.20mΩ (Initial value)	
	Electric Life Cycle	Min. 100 thousand (20 times/min)	
LED block	Rated Voltage	DC type : 12-24VAC/DC, AC type : 110-220VAC	
	Power Consumption	Max. 20mA	
	Ambient Temperature	-15 ~ 55 °C (at non-freezing status)	
Environmental Characteristics	Ambient Humidity	35 ~ 85%RH	
	Storage Temperature	-25 ~ 65 °C (at non-freezing status)	
	Protection Degree	IP52 (IP 50 for double push button switch)	
Approval	 (Emergency switches is  process of certification)		



Push Button Switches

S	2	PR	-	P1	R	A	D
①	②	③		④	⑤	⑥	⑦

Classification	Ordering Information							Description	
	①	②	③	-	④	⑤	⑥		⑦
Model	S							Control Switches	
Dimension	2							Ø22/25	
	3							Ø30	
Appearance			PR					Push button switches (Non-Flush)	
			PF					Push button switches (Flush)	
Operation					P1			Auto spring return (Non-Illuminated)	
					P3			Auto spring return (Illuminated)	
Color					R			RED	
					B			BLUE	
					G			GREEN	
					Y			YELLOW	
					K			BLACK (Available for Non-Illuminated type only)	
					W			WHITE (Available for Illuminated type only)	
Contact / LED Block						A		A (Normal open) 110VAC/10A, 250VAC/6A	
						B		B (Normal close) 110VAC/10A, 250VAC/6A	
							D	LED 12-24VDC/AC	
							L	LED 110-220VAC	

● Ø22/25 Push Button Switches(Non-Flush)



Model	Contacts	
	A Contact	B Contact
S2PR - P1□A	1EA	
" - " □2A	2EA	
" - " □3A	3EA	
" - " □B		1EA
" - " □2B		2EA
" - " □3B		3EA
" - " □AB	1EA	1EA
" - " □2AB	2EA	1EA
" - " □A2B	1EA	2EA

※ Represents colors □ : R, B, G, Y, K

- Easy assembly and removal by one touch
- Mounting hole layout : Ø22.5 / 25.5mm
- Waterproof cap available (SA-WP)

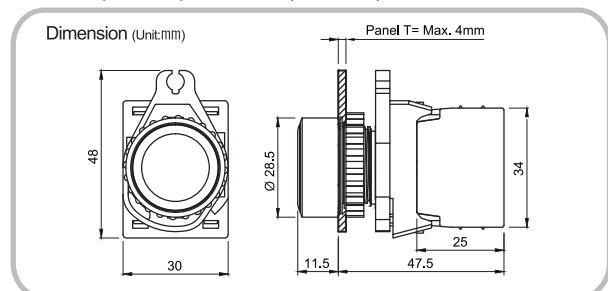



● Ø30 Push Button Switches (Non-Flush)



Model	Contacts	
	A Contact	B Contact
S3PR - P1□A	1EA	
" - " □2A	2EA	
" - " □3A	3EA	
" - " □B		1EA
" - " □2B		2EA
" - " □3B		3EA
" - " □AB	1EA	1EA
" - " □2AB	2EA	1EA
" - " □A2B	1EA	2EA

※ Represents colors □ : R, B, G, Y, K
● ● ● ● ●

- Simple and elegant design
- Mounting hole layout : Ø30.5mm

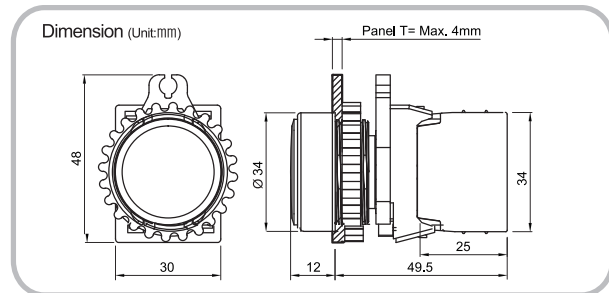

● Ø30 Push Button Switches (Flush)



Model	Contacts	
	A Contact	B Contact
S3PF - P1□A	1EA	
" - " □2A	2EA	
" - " □3A	3EA	
" - " □B		1EA
" - " □2B		2EA
" - " □3B		3EA
" - " □AB	1EA	1EA
" - " □2AB	2EA	1EA
" - " □A2B	1EA	2EA

※ Represents colors □ : R, B, G, Y, K
● ● ● ● ●

- Mounting hole layout : Ø30.5mm

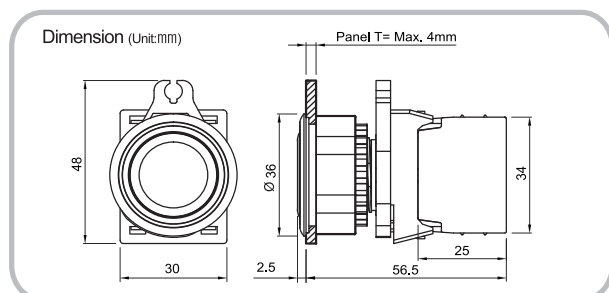

Push Button Switches

Push Button Switches (Illuminated)

Selector Switches

Double Push Button Switches

Start Push Button Switches

Emergency Switches

Emergency Switches (Illuminated)

Pilot Lamps

Accessories

Magnetic Buzzers

Piezo Buzzers

Sockets



Push Button Switches (Illuminated)

● Ø22/25 Push Button Switches (Illuminated / Non-Flush)



Model	Contacts		LED	
	A Contact	B Contact	DC Type	AC Type
S2PR - P3□AD	1EA		1EA	
" - " □2AD	2EA		1EA	
" - " □BD		1EA	1EA	
" - " □2BD		2EA	1EA	
" - " □ABD	1EA	1EA	1EA	
" - " □AL	1EA			1EA
" - " □2AL	2EA			1EA
" - " □BL		1EA		1EA
" - " □2BL		2EA		1EA
" - " □ABL	1EA	1EA		1EA

※ Represents colors □ : R, B, G, Y, W
● ● ● ● ○

- Simple and elegant design
- Mounting hole layout : Ø22.5 / 25.5mm
- Mounting hole layout (SA - WL)

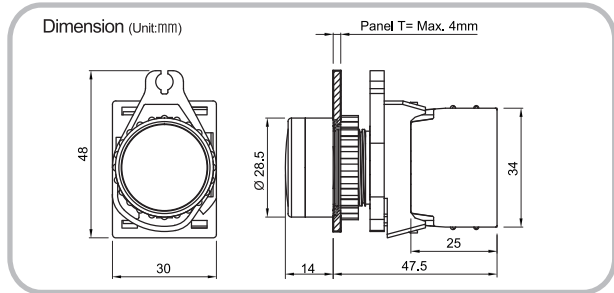

● Ø30 Push Button Switches (Illuminated / Flush)



Model	Contacts		LED	
	A Contact	B Contact	DC Type	AC Type
S3PF - P3□AD	1EA		1EA	
" - " □2AD	2EA		1EA	
" - " □BD		1EA	1EA	
" - " □2BD		2EA	1EA	
" - " □ABD	1EA	1EA	1EA	
" - " □AL	1EA			1EA
" - " □2AL	2EA			1EA
" - " □BL		1EA		1EA
" - " □2BL		2EA		1EA
" - " □ABL	1EA	1EA		1EA

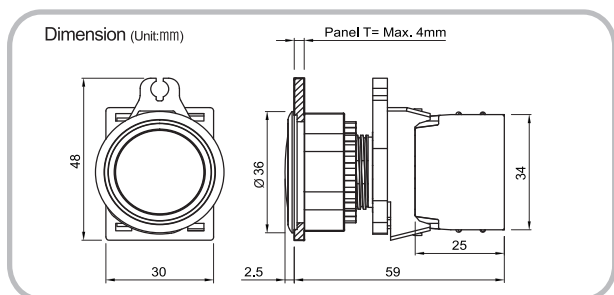

※ Represents colors □ : R, B, G, Y, W
● ● ● ● ○

- Mounting hole layout : Ø30.5mm





S **2** **SR** - **S7** **W** **A**
 ① ② ③ - ④ ⑤ ⑥

Classification	Ordering Information						Description
	①	②	③	-	④	⑤	
Model	S						Control Switches
Dimension		2					Ø22/25
		3					Ø30
Appearance			SR				Selector Switches (Non-Flush)
			SF				Selector Switches (Flush)
Operation					S3		2 Positions maintained (Short lever)
					S4		2 Positions maintained (Long lever)
					S5		3 Positions Both auto spring return (Short lever)
					S6		3 Positions Both auto spring return (Long lever)
					S7		3 Positions Both maintained (Short lever)
					S8		3 Positions Both maintained (Long lever)
Color						R	RED
						W	WHITE
Contact						A	A (Normal Open) 110VAC/10A, 250VAC/6A 
						B	B (Normal Close) 110VAC/10A, 250VAC/6A 

<< Operation Description >>

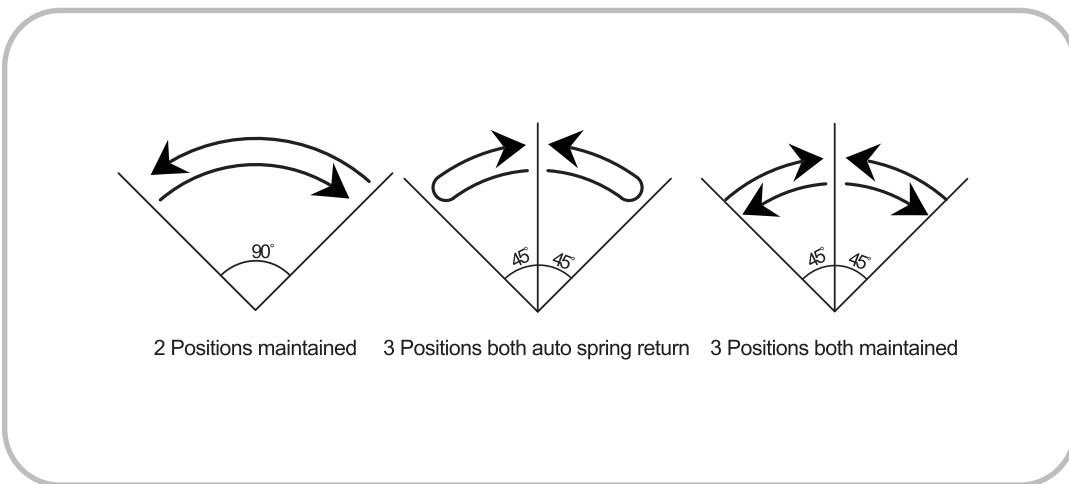

Push Button Switches

Push Button Switches (Illuminated)

Selector Switches

Double Push Button Switches

Start Push Button Switches

Emergency Switches

Emergency Switches (Illuminated)

Pilot Lamps

Accessories

Magnetic Buzzers

Piezo Buzzers

Sockets



Selector Switches

● Ø22/25 Short Lever Selector Switches (Non-Flush)



	Model	Contacts		Model	Contacts		
		A Contact	B Contact		A Contact	B Contact	
2 Positions Maintained	S2SR - S3□A	1EA		S2SR - S7□2A	2EA		
	" - " □2A	2EA			" - " □2B	2EA	
	" - " □B		1EA		" - " □AB	1EA	1EA
	" - " □2B		2EA				
	" - " □AB	1EA	1EA				
3 Positions Both Auto Spring Return	S2SR - S5□2A	2EA		※ Represents colors □ : W, R ○ ●			
	" - " □2B		2EA				
	" - " □AB	1EA	1EA	2 Positions maintained (S3) 3 Positions both auto spring return (S5) 3 Positions both maintained (S7)			

- Smooth and Swift switch operation
- Mounting hole layout : Ø22.5 / 25.5mm

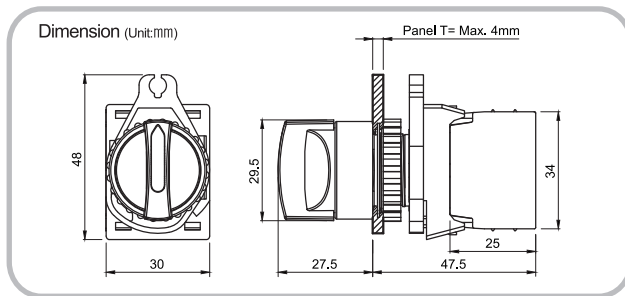

● Ø22/25 Long Lever Selector Switches (Non-Flush)



	Model	Contacts		Model	Contacts		
		A Contact	B Contact		A Contact	B Contact	
2 Positions Maintained	S2SR - S4□A	1EA		S2SR - S8□2A	2EA		
	" - " □2A	2EA			" - " □2B	2EA	
	" - " □B		1EA		" - " □AB	1EA	1EA
	" - " □2B		2EA				
	" - " □AB	1EA	1EA				
3 Positions Both Auto Spring Return	S2SR - S6□2A	2EA		※ Represents colors □ : W, R ○ ●			
	" - " □2B		2EA				
	" - " □AB	1EA	1EA	2 Positions maintained (S4) 3 Positions both auto spring return (S6) 3 Positions both maintained (S8)			

- Smooth and Swift switch operation
- Mounting hole layout : Ø22.5 / 25.5mm

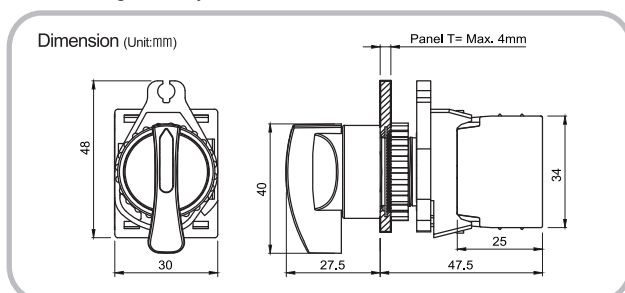



● Ø30 Short Lever Selector Switches (Flush)



	Model	Contacts			Model	Contacts		
		A Contact	B Contact			A Contact	B Contact	
2 Positions Maintained	S3SF - S3□A	1EA		3 Positions Both Maintained	S3SF - S7□2A	2EA		
	" - " □2A	2EA			" - " □2B		2EA	
	" - " □B		1EA		" - " □AB	1EA	1EA	
	" - " □2B		2EA					
	" - " □AB	1EA	1EA					
3 Positions Both Auto Spring Return	S3SF - S5□2A	2EA		※ Represents colors □ : W, R ○ ●				
	" - " □2B		2EA					
	" - " □AB	1EA	1EA	2 Positions maintained(S3) 3 Positions both auto spring return(S5) 3 Positions both maintained(S7)				

- Simple and elegant design
- Mounting hole layout : Ø30.5mm

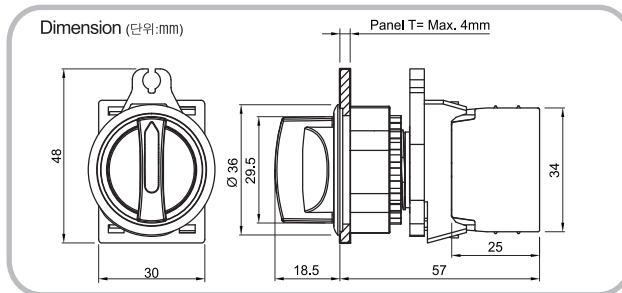

● Ø30 Long Lever Selector Switches (Flush)



	Model	Contacts			Model	Contacts		
		A Contact	B Contact			A Contact	B Contact	
2 Positions Maintained	S3SF - S4□A	1EA		3 Positions Both Maintained	S3SF - S8□2A	2EA		
	" - " □2A	2EA			" - " □2B		2EA	
	" - " □B		1EA		" - " □AB	1EA	1EA	
	" - " □2B		2EA					
	" - " □AB	1EA	1EA					
3 Positions Both Auto Spring Return	S3SF - S6□2A	2EA		※ Represents colors □ : W, R ○ ●				
	" - " □2B		2EA					
	" - " □AB	1EA	1EA	2 Positions maintained(S4) 3 Positions both auto spring return(S6) 3 Positions both maintained(S8)				

- Simple and elegant design
- Mounting hole layout : Ø30.5mm

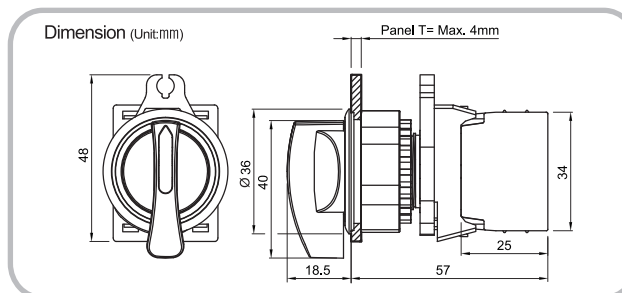

Push Button Switches

Push Button Switches (Illuminated)

Selector Switches

Double Push Button Switches

Start Push Button Switches

Emergency Switches

Emergency Switches (Illuminated)

Pilot Lamps

Accessories

Magnetic Buzzers

Piezo Buzzers

Sockets



Double Push Button Switches

S	2	TR	-	P3	W	AB	D
①	②	③		④	⑤	⑥	⑦

Classification	Ordering Information							Description		
	①	②	③	-	④	⑤	⑥		⑦	
Model	S								Control Switches	
Dimension	2								Ø22/25	
Appearance			TR						Double push button switches	
Operation					P3				Spring return type, Illuminated	
Color						W			WHITE	
Contact / LED Block							A		A (Normal Open) 110VAC/10A, 250VAC/6A	
							B		B (Normal Close) 110VAC/10A, 250VAC/6A	
							D		LED 12-24VDC/AC	
							L		LED 110-220VAC	

● Ø22/25 Double Push Button Switches (Non-Flush)



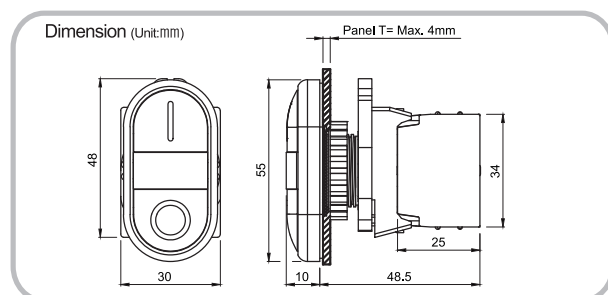

Model	Contacts		LED	
	A Contact	B Contact	DC Type	AC Type
S2TR - P3WABD	1EA	1EA	1EA	
S2TR - P3WABL	1EA	1EA		1EA

- Soft streamlined design
- Mounting hole layout : Ø22.5 / 25.5mm





S	2	BR	-	P1	G	A
①	②	③		④	⑤	⑥

Classification	Ordering Information						Description
	①	②	③	-	④	⑤	
Model	S						Control Switches
Dimension		2					Ø22/25
Appearance			BR				Start push button switches
Operation					P1		Spring return type, Illuminated
Color					G		GREEN
					R		RED
Contact						A	A (Normal Open) 110VAC/10A, 250VAC/6A 
						B	B (Normal Close) 110VAC/10A, 250VAC/6A 

Push Button Switches

Push Button Switches (Illuminated)

Selector Switches

Double Push Button Switches

Start Push Button Switches

Emergency Switches

Emergency Switches (Illuminated)

Pilot Lamps

Accessories

Magnetic Buzzers

Piezo Buzzers

Sockets

● Ø22/25 Start Push Button Switches (Non-Flush)



Model	Contacts	
	A Contact	B Contact
S2BR - P1□A	1EA	
" - " □2A	2EA	
" - " □3A	3EA	
" - " □B		1EA
" - " □2B		2EA
" - " □3B		3EA
" - " □AB	1EA	1EA
" - " □2AB	2EA	1EA
" - " □A2B	1EA	2EA

※ Represents colors □ : R, G



- Mushroom-head shaped design
- Mounting hole layout : Ø22.5 / 25.5mm

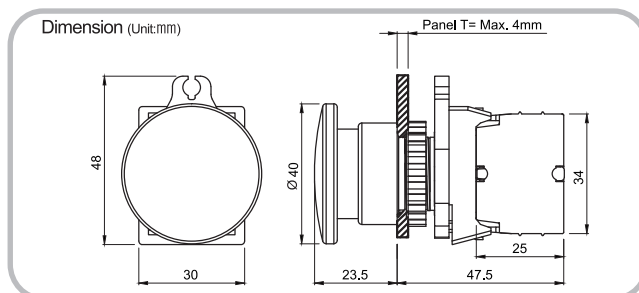



S	2	ER	-	E1	R	B	D
①	②	③		④	⑤	⑥	⑦

Classification	Ordering Information							Description	
	①	②	③	-	④	⑤	⑥		⑦
Model	S							Control switches	
Dimension	2							Ø22/25	
Appearance			ER					Emergency switches	
Operation				E1				Head Ø30(L) Push-Lock, Turn-Reset	
				E2				Head Ø30(S) Push-Lock, Turn-Reset	
				E3				Head Ø40 Push-Lock, Turn-Reset	
				E4				Head Ø40 Push-Lock, Turn-Reset(Illuminated)	
				E5				Head Ø60 Push-Lock, Turn-Reset	
Color					R			RED	
Contact / LED Block						A		A (Normal Open) 110VAC/10A, 250VAC/6A	
						B		B (Normal Close) 110VAC/10A, 250VAC/6A	
						D		LED 12-24VDC/AC	
						L		LED 110-220VAC	

● Ø22/25 Head D30L Emergency Switches (Non-Flush)



Model	Contacts	
	A Contact	B Contact
S2ER - E1RA	1EA	
" - " 2A	2EA	
" - " 3A	3EA	
" - " B		1EA
" - " 2B		2EA
" - " 3B		3EA
" - " AB	1EA	1EA
" - " 2AB	2EA	1EA
" - " A2B	1EA	2EA

- Space-saving design
- Mounting hole layout : Ø22.5 / 25.5mm
- PUSH LOCK & TURN RESET

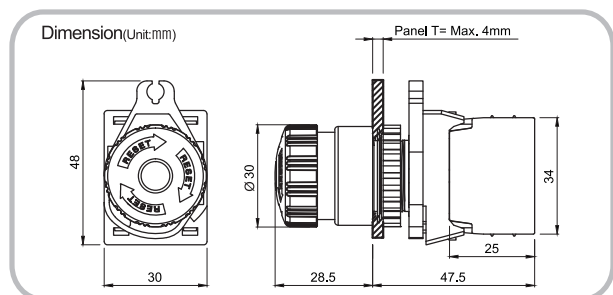



● Ø22/25 Head D30S Emergency Switches (Non-Flush)



Model	Contacts	
	A Contact	B Contact
S2ER - E2RA	1EA	
" - " 2A	2EA	
" - " 3A	3EA	
" - " B		1EA
" - " 2B		2EA
" - " 3B		3EA
" - " AB	1EA	1EA
" - " 2AB	2EA	1EA
" - " A2B	1EA	2EA

- Space-saving design
- Mounting hole layout : Ø22.5 / 25.5mm
- PUSH LOCK & TURN RESET

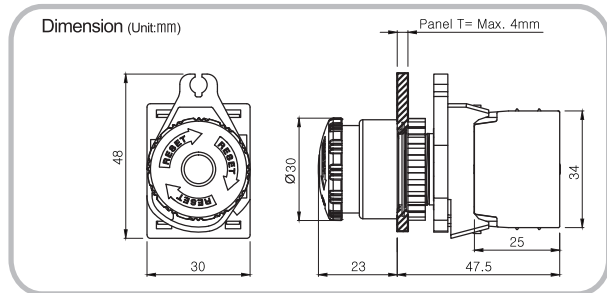

● Ø22/25 Head D40 Emergency Switches (Non-Flush)



Model	Contacts	
	A Contact	B Contact
S2ER - E3RA	1EA	
" - " 2A	2EA	
" - " 3A	3EA	
" - " B		1EA
" - " 2B		2EA
" - " 3B		3EA
" - " AB	1EA	1EA
" - " 2AB	2EA	1EA
" - " A2B	1EA	2EA

- Simple and elegant design
- Mounting hole layout : Ø22.5 / 25.5mm
- PUSH LOCK & TURN RESET

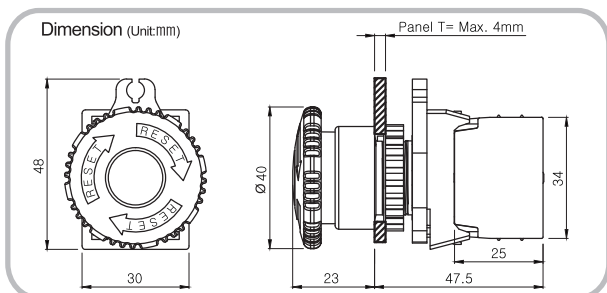

Push Button Switches

Push Button Switches (Illuminated)

Selector Switches

Double Push Button Switches

Start Push Button Switches

Emergency Switches

Emergency Switches (Illuminated)

Pilot Lamps

Accessories

Magnetic Buzzers

Piezo Buzzers

Sockets



● **Ø22/25 Head D40 Emergency Switches (Illuminated Non-Flush)**



Model	Contacts		LED	
	A Contact	B Contact	DC Type	AC Type
S2ER - E4RAD	1EA		1EA	
" - " 2AD	2EA		1EA	
" - " BD		1EA	1EA	
" - " 2BD		2EA	1EA	
" - " ABD	1EA	1EA	1EA	
" - " AL	1EA			1EA
" - " 2AL	2EA			1EA
" - " BL		1EA		1EA
" - " 2BL		2EA		1EA
" - " ABL	1EA	1EA		1EA

- Improved visibility with high luminance LED
- Mounting hole layout : Ø22.5 / 25.5mm
- PUSH LOCK & TURN RESET

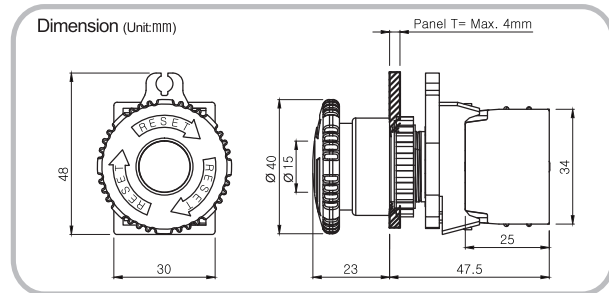
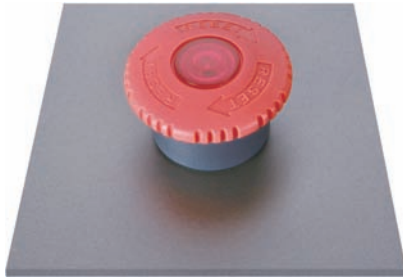

● **Ø22/25 Head D60 Emergency Switches (Non-Flush)**



Model	Contacts	
	A Contact	B Contact
S2ER - E5RA	1EA	
" - " 2A	2EA	
" - " 3A	3EA	
" - " B		1EA
" - " 2B		2EA
" - " 3B		3EA
" - " AB	1EA	1EA
" - " 2AB	2EA	1EA
" - " A2B	1EA	2EA

- Increasing user convenience with large size head (Ø60)
- Mounting hole layout : Ø22.5 / 25.5mm
- PUSH LOCK & TURN RESET

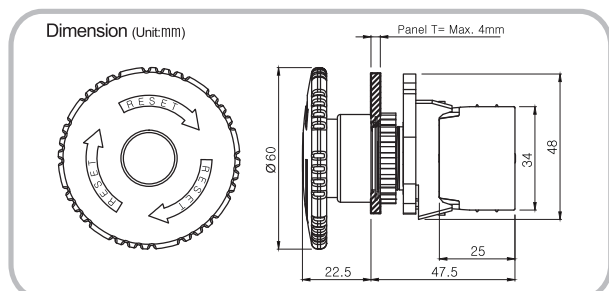



Push Button Switches

Push Button Switches (Illuminated)

Selector Switches

Double Push Button Switches

Start Push Button Switches

Emergency Switches

Emergency Switches (Illuminated)

Pilot Lamps

Accessories

Magnetic Buzzers

Piezo Buzzers

Sockets

L 2 RR - L2 R D
 ① ② ③ ④ ⑤ ⑥

Classification	Ordering Information						Description
	①	②	③	-	④	⑤ ⑥	
Model	L						Pilot lamps
Dimension	2						Ø22/25
	3						Ø30
Appearance			RR				Round pilot lamps (Non-Flush)
			RF				Round pilot lamps (Flush)
Head Type					L1		DOME HEAD
					L2		HORN HEAD
					L3		FLAT HEAD
Color					R		RED
					B		BLUE
					G		GREEN
					Y		YELLOW
					W		WHITE
Contact						D	LED 12-24VDC/AC
						L	LED 110-220VAC

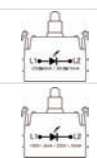

● Ø22/25 DOME TYPE Pilot Lamps

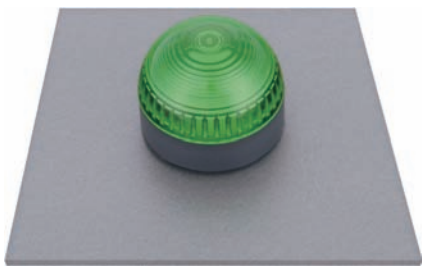

Model	LED	
	DC Type	AC Type
L2RR - L1□D	1EA	
" - " □L		1EA

※ Represents colors □ : R, B, G, Y, W

- Improved visibility with high luminance LED
- Mounting hole layout : Ø22.5 / 25.5mm

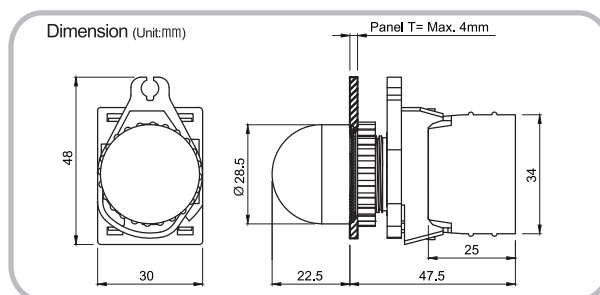



● Ø22/25 HORN TYPE Pilot Lamps

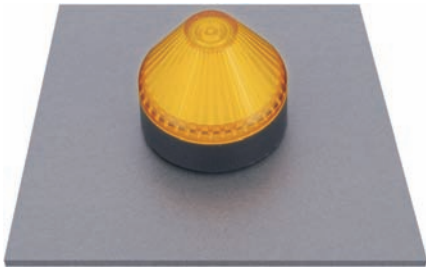

Model	LED	
	DC Type	AC Type
L2RR - L2□D	1EA	
" - " □L		1EA

※ Represents colors □ : R, B, G, Y, W
● ● ● ● ●

- Improved visibility with high luminance LED
- Mounting hole layout : Ø22.5 / 25.5mm

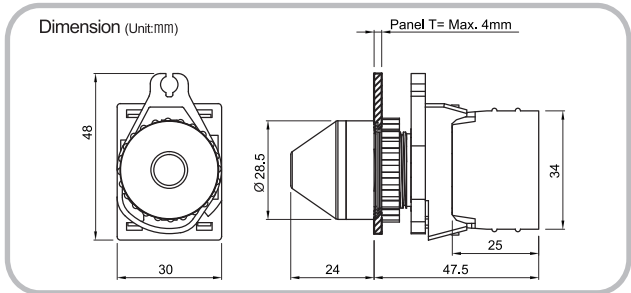

● Ø22/25 FLAT TYPE Pilot Lamps (Non-Flush)



Model	LED	
	DC Type	AC Type
L2RR - L3□D	1EA	
" - " □L		1EA

※ Represents colors □ : R, B, G, Y, W
● ● ● ● ●

- Simple and elegant design
- Mounting hole layout : Ø22.5 / 25.5mm

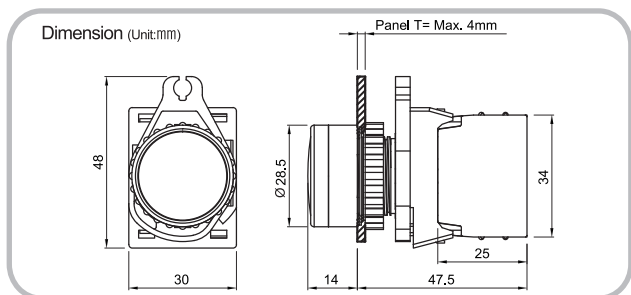



● Ø30 FLAT TYPE Pilot Lamps(Flush)



Model	LED	
	DC Type	AC Type
L3RF - L3□D	1EA	
" - " □L		1EA

※ Represents colors □ : R, B, G, Y, W
● ● ● ● ○

● Mounting hole layout : Ø30.5mm

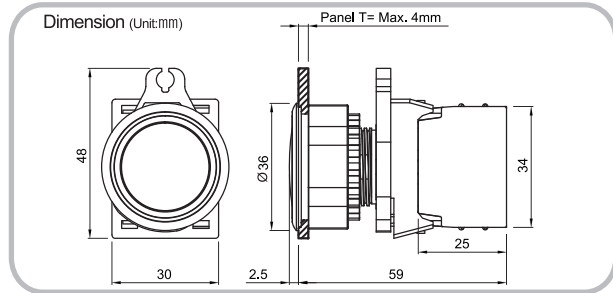

< Memo >

Push Button Switches

Push Button Switches (Illuminated)

Selector Switches

Double Push Button Switches

Start Push Button Switches

Emergency Switches

Emergency Switches (Illuminated)

Pilot Lamps

Accessories

Magnetic Buzzers

Piezo Buzzers

Sockets

● **Switch Contact Blocks**

SA ① - CA ②		Ordering Information		Description	
Classification	①	-	②		
Model	SA			Switches Accessories	
Contact /LED Block			CA	A Contact (Normal open)	
			CB	B Contact (Normal close)	
			LD	LED Block (12-24VDC/AC)	
			LA	LED Block (110-220VAC 50/60HZ)	

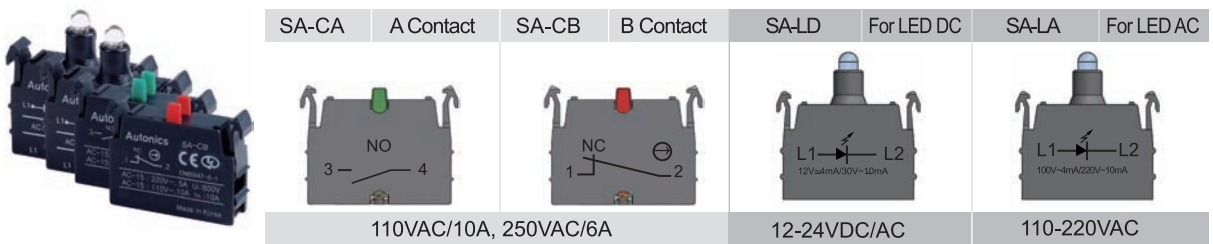

● **Switch Boxes**

SA ① - SB ② 1 ③		Ordering Information		Description		
Classification	①	-	②	③		
Model	SA				Switches accessories	
Appearance			SB		Square boxes (Square type)	
			TB		Triangle boxes	
Number of holes				1	1 hole (Length : L=86mm)	
				2	2 hole (Length : L=136mm)	
				3	3 hole (Length : L=186mm)	
				4	4 hole (Length : L=236mm)	
				5	5 hole (Length : L=286mm)	

※ The number of holes and box length can be customized

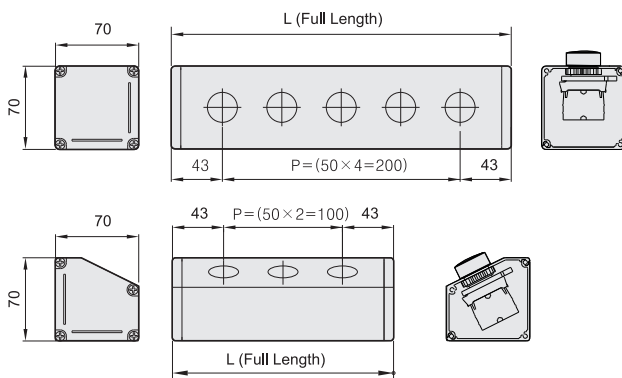

Dimensions (Unit : mm)
Mounting hole layout $\varnothing 22.5/25.5$



● Emergency Switch Nameplates

SA	-	NS		
①		②		
Classification		Ordering Information		Description
Model	SA			
Appearance		NS		
		NL		Nameplate large size

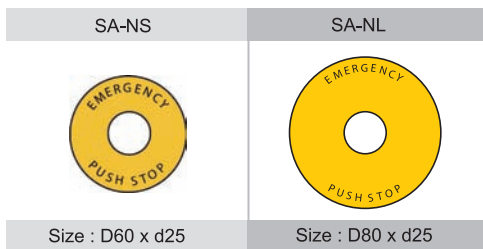

Panel mounting hole layout

It is recommended to leave the interval of 50 mm between each panel hole. In case of S2RE-E5R, leave the interval of 60mm or more.

(Unit : mm)

● Emergency Switch Protective Shrouds

SA	-	EG	1	
①		②	③	
Classification		Ordering Information		Description
Model	SA			
Appearance		EG		
Dimension			1	Ø22, SMALL
			2	Ø22, LARGE
			3	Ø25, LARGE

• Dimensions for small type

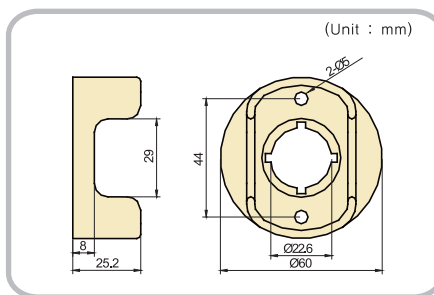

• Dimensions for large type

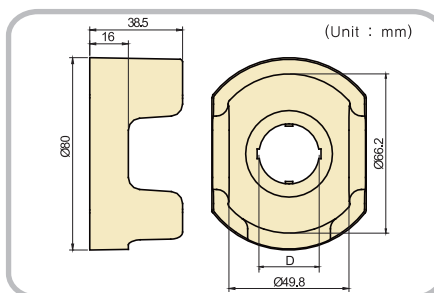

D Part Dimension	
SA-EG2	Ø22.5
SA-EG3	Ø25.5

Push Button Switches

Push Button Switches (Illuminated)

Selector Switches

Double Push Button Switches

Start Push Button Switches

Emergency Switches

Emergency Switches (Illuminated)

Pilot Lamps

Accessories

Magnetic Buzzers

Piezo Buzzers

Sockets

● **Water Proof Cap**

SA	-	WP	
①		②	
Classification	Ordering Information		Description
Model	①	-	②
Appearance	SA		WP
			WL
			For illuminated push button

(Unit : mm)

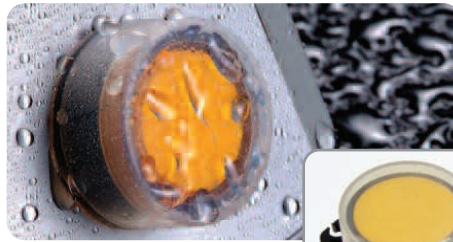
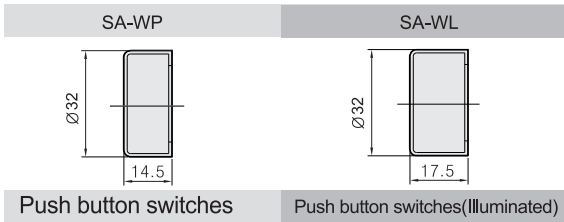

※ For Non-flush $\varnothing 22/25$ Non-flush switches

● **Locking Handle for Switches**

SA	-	LH	
①		②	
Classification	Ordering Information		Description
Model	①	-	②
Appearance	SA		LH
			Locking ring wrench (Locking handle)

(Unit : mm)

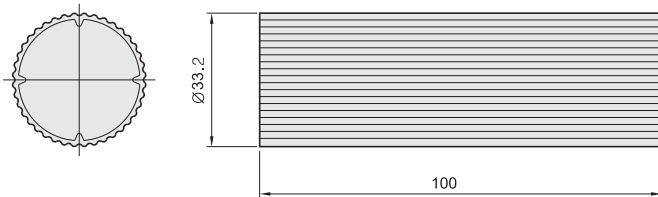

When mounting $\varnothing 25$ panel hole,



When mounting $\varnothing 22$ panel hole, contact B part

● **Guideline for mounting switch nut**

Available for $\varnothing 22/25$ flush push buttons. When mounting $\varnothing 25$ panel hole, contact A part with switch nut . When mounting $\varnothing 22$ panel hole, contact B part with switch nut



■ Buzzers

Classification	Magnetic Buzzers	Piezo Buzzers	
Mounting Hole	Ø22 / 25	Ø22 / 25	Ø30
Model	B2NB - B1D	B2PB - B1D, B2D, B3D	B3PB - B1D, B2D, B3D
Appearance			
Page	24	24	24

■ Specifications

Model	B2NB - B1D	B2PB - B1D, B2D, B3D	B3PB - B1D, B2D, B3D
Rated Voltage	12-24VDC		
Rated Current	Max.60mA	Max.25mA	
Sound Level	Approx.75dB(1m) Approx.85dB(0.1m)	Approx.85dB(0.1m)	
Sound Type	Continuous / Intermittent (Selectable)	Continuous / Intermittent (Selectable), Continuous, Intermittent	
Insulation Resistance	Min. 50MΩ(at 500VDC)	Min. 100MΩ(at 500VDC)	
Dielectric Strength	1,000VAC 50/60Hz for 1 minute	2,000VAC 50/60Hz for 1 minute	
Vibration Resistance	1.5mm amplitude at frequency of 10~55Hz(for 1minute) in each of x,y,z directions for 2 hours		
Shock Resistance	500m/s ² (50G) in each of x,y,z directions for 3 times	300m/s ² (30G) in each of x,y,z directions for 3 times	
Ambient Temperature	-15 ~ 55 °C (at non-freezing status)		
Storage Temperature	-25 ~ 65 °C (at non-freezing status)		
Ambient Humidity	35 ~ 85%RH		
Protection Degree	IP30		
Material	Body	Nylon6	
	Cover	PC	
Unit Weight	Approx.18g	Approx. 20g	Approx.25g

< Memo >

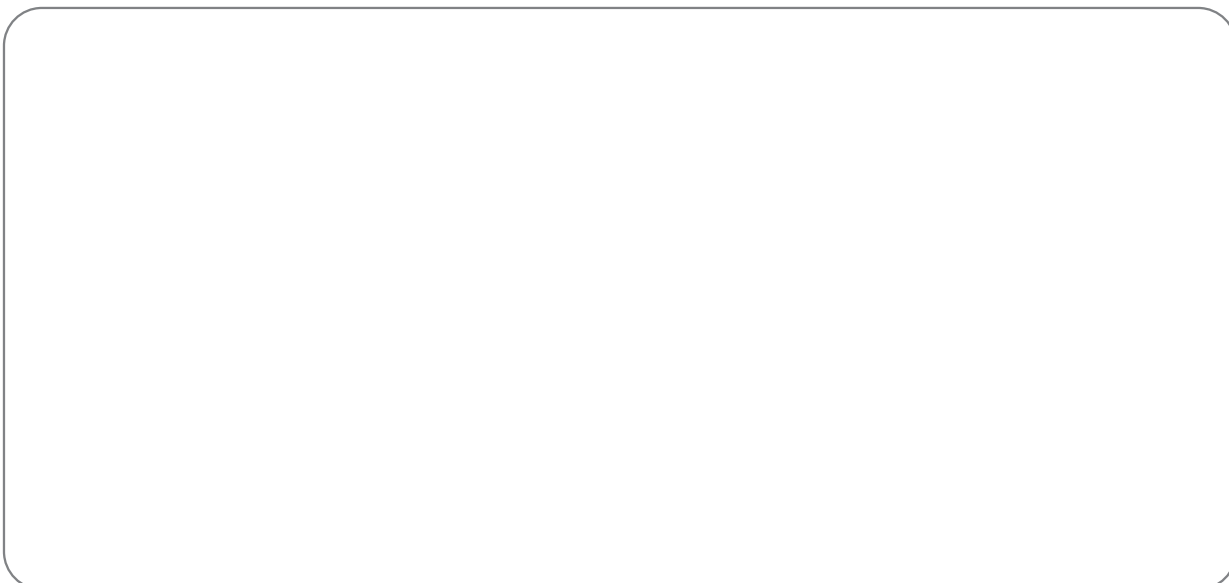

Push Button Switches

Push Button Switches (Illuminated)

Selector Switches

Double Push Button Switches

Start Push Button Switches

Emergency Switches

Emergency Switches (Illuminated)

Pilot Lamps

Accessories

Magnetic Buzzers

Piezo Buzzers

Sockets



Classification	Ordering Information					Description
	①	②	③	-	④	
Model	B					Buzzers
Dimension	2					Ø22/25
	3					Ø30
Appearance			NB			Magnetic buzzers
			PB			Piezo buzzers
Sound				B1		Continuous / Intermittent (Selectable)
				B2		Continuous
				B3		Intermittent
Power Supply					D	12 - 24VDC

● Ø22/25 Magnetic Buzzers(Non-Flush)



Model	B2NB - B1D
-------	------------

- Mounting hole layout : Ø22.5 / 25.5mm
- Continuous and intermittent sound selectable
- High visibility with LED

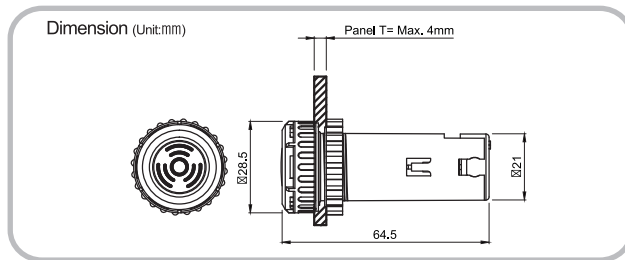

● Ø22/25 Piezo Buzzers(Non-Flush)

launching soon



Model	Sound
B2PB - B1D	Continuous / Intermittent(Selectable)
B2PB - B2D	Continuous
B2PB - B3D	Intermittent

- Simple and polished design
- Mounting hole layout : Ø22.5 / 25.5mm

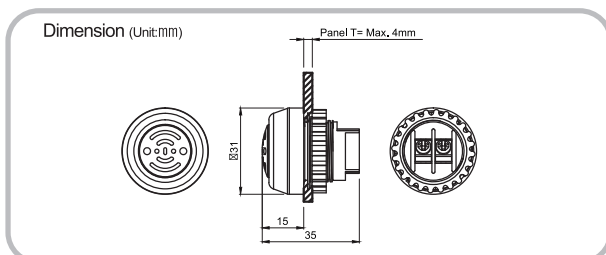

● Ø30 Piezo Buzzers(Flush)

launching soon





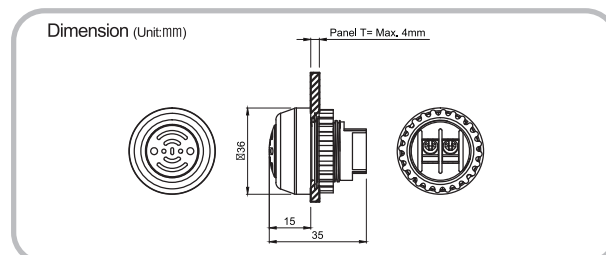

Model	Sound
B3PB - B1D	Continuous / Intermittent(Selectable)
B3PB - B2D	Continuous
B3PB - B3D	Intermittent

- Simple and polished design
- Mounting hole layout : Ø30.5mm

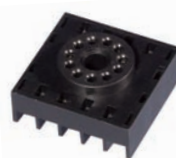

■ Sockets

Classification	Standard Type		Din Rail / Wall Mounting Type		
	8PIN	11PIN	8PIN	11PIN	8 PIN (MINI SIZE)
Model	PG - 08	PG - 11	PS - 08	PS-11	PS-M8
Appearance					
Page	26	27	27	28	28

Push Button Switches

Push Button Switches (Illuminated)

Selector Switches

Double Push Button Switches

Start Push Button Switches

Emergency Switches

Emergency Switches (Illuminated)

Pilot Lamps



Accessories

Magnetic Buzzers

Piezo Buzzers

Sockets

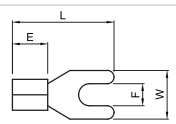
■ Specifications

Model	PG - 08	PG - 11	PS - 08	PS - 11	PS - M8
Rated Voltage	250VAC				
Rated Current	7A (Load resistance)				
Insulation Resistance	Min. 100MΩ(at 500VDC)				
Dielectric Strength	2000VAC 50/60Hz for 1 minute				
Vibration Resistance	0.75mm amplitude at frequency of 10~55Hz(for 1minute) in each of x,y,z directions for 2 hours				
Shock Resistance	980m/s(98G) in each of x,y,z directions for 3 times(In case of PS-M8, 300m/s (30G) in each of x,y,z directions for 3 times.)				
Ambient Temperature	-10 ~ 55 °C (at non-freezing status)				
Storage Temperature	-25 ~ 65 °C (at non-freezing status)				
Ambient Humidity	35 ~ 85%RH				
Socket Torque	0.8N•m(In case of PS-M8, 0.75N•m~0.95N•m)				
Standard Screw	M3,5				
Material	Body	PBT			
	Bolt	Steel Ni Plated			
	Nut	Steel Ni Plated			
	Terminal	PBIC Ni Plated			
Connection	E		4.5mm less than		
	F		Ø3.6 more than		
	W		6.8~7.1mm		
	L		15.7mm more than		
Approval					
Unit Weight	Approx. 37.5g	Approx. 47g	Approx. 62g	Approx. 85g	Approx. 43g

P **G** **-** **08**
 ① ② ③

Classification	Ordering Information			Description
	①	②	③	
Model	P			Sockets
Appearance		G		Standard type
Terminal			08	8 Pin
			11	11 Pin
Appearance		S		Din Rail / Wall mounting type
Terminal			08	8 Pin
			11	11 Pin
			M8	M8 Pin (Mini size-ATS series only)

● **Standard Type Socket**



Model PG-08

- High heat resisting property and insulation resistance with PBT(UL94-V0 resin)-plated body
- Improved electrical capability and reliable connection with connection terminal made of copper alloy

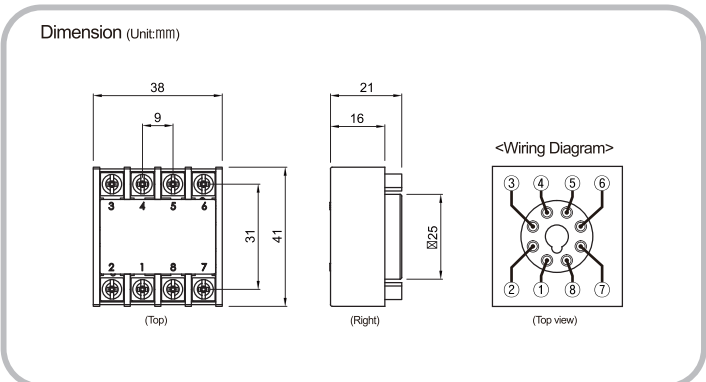

- Standard Type Socket



Model	PG-11
-------	-------

- High heat resisting property and insulation resistance with PBT(UL94-V0 resin)-plated body.
- Improved electrical capability and reliable connection with connection terminal made of copper alloy

Dimension (Unit:mm)

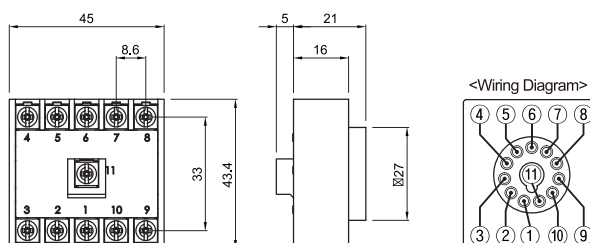

- Din Rail / Wall Mounting Type



Model	PS-08
-------	-------

- One touch for easy mounting on RAIL
- When mounting panel, Fix it with M4*0.7 screw
- High heat resisting property and insulation resistance with PBT(UL94-V0 resin)-plated body.
- Improved electrical capability and reliable connection with connection terminal made of copper alloy

Dimension (Unit:mm)

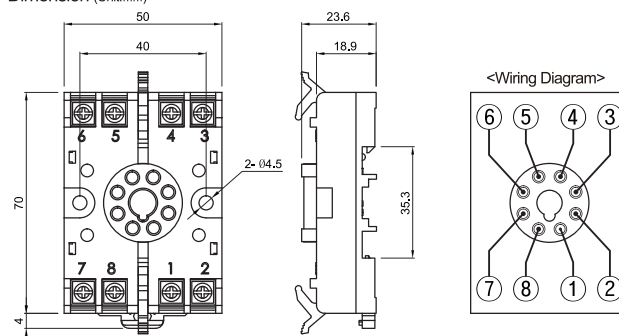
Push
Button
SwitchesPush
Button
Switches
(Illuminated)Selector
SwitchesDouble
Push
Button
SwitchesStart
Push
button
SwitchesEmergency
SwitchesEmergency
Switches
(Illuminated)Pilot
Lamps

Accessories

Magnetic
BuzzersPiezo
Buzzers

Sockets

● Din Rail / Wall Mounting Type



Model	PS-11
-------	-------

- One touch for easy mounting on RAIL
- When mounting panel, fix it with M4*0.7 screw
- High heat resisting property and insulation resistance with PBT(UL94-V0 resin)-plated body
- Improved electrical capability and reliable connection with connection terminal made of copper alloy

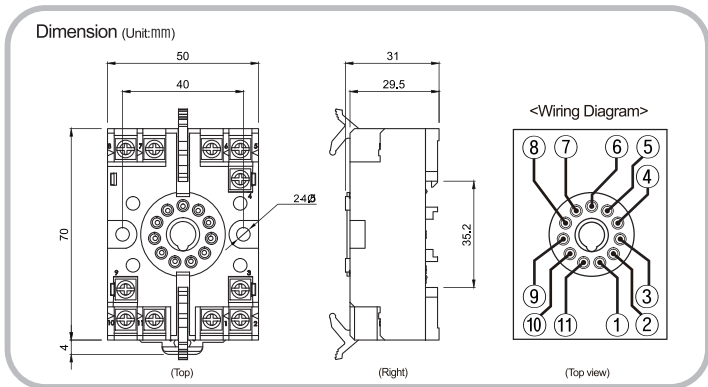

● Din Rail / Wall Mounting Type



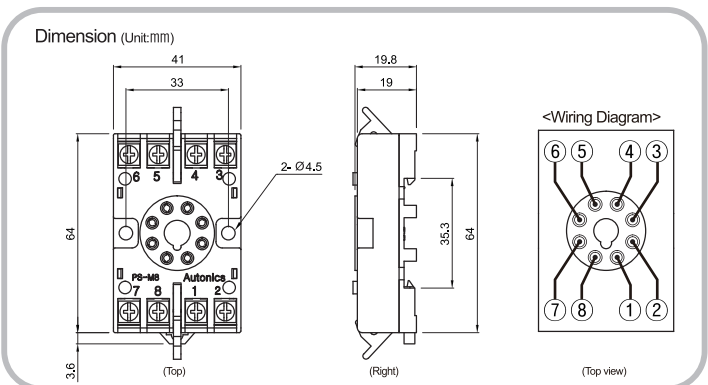

Model	PS-M8
-------	-------

- Well designed for 40mm width products (For ATS Series)
- One touch for easy mounting on RAIL
- When mounting panel, fix it with M4*0.7 screw
- High heat resisting property and insulation resistance with PBT(UL94-V0 resin)-plated body
- Improved electrical capability and reliable connection with connection terminal made of copper alloy



■ Digital Switches Series

Classification	Digital Switches (Small)	Digital Switches (Standard)	
		Relay Pattern	Standard Pattern
Model	AD105-I, B	AD604-I, B	AD605-I, B
Appearance			
Page	30	31	

Push Button Switches

Push Button Switches (Illuminated)

Selector Switches

Double Push Button Switches

Start Push Button Switches

Emergency Switches

Emergency Switches (Illuminated)

Pilot Lamps

Accessories

Magnetic Buzzers

Piezo Buzzers

Sockets

Digital Switches

■ Specifications

Model	AD105-I, B	AD604-I, B	AD605-I, B
Operation Capacity	Max.500gf (4.9N)	Max.550gf (5.39N)	
Load Capacity	5-28VDC, 1mA~0.1A	5-28VDC, 50VAC 50/60Hz 1mA~0.1A	
Continuous Carry Current	Max. 100mA	Max. 1A	
Contact Resistance	Max. 200mΩ		
Insulation Resistance	Min. 100mΩ (at 250VDC for 1minute)		
Resistance	Min. 100mΩ (at 500VDC for 1minute)		
Dielectric Strength	Between Non-Connected Terminals	250VAC 50/60Hz for 1 minute	600VAC 50/60Hz for 1 minute
	Between Terminal and Non-Current Carrying Part	500VAC 50/60Hz for 1 minute	1000VAC 50/60Hz for 1 minute
Vibration Resistance	0.75mm amplitude at frequency of 10~55Hz (for 1minute) in each of x,y,z directions for 1 hours		
Shock Resistance	500m/s (50G) in each of x,y,z directions for 3 times		
Durability	Electrical	More than 20,000 times	
	Mechanical	More than 30,000 times	
Ambient Temperature	-10 ~ 50 °C (at non-freezing status)		
Storage Temperature	-20 ~ 80 °C (at non-freezing status)		
Ambient Humidity	45 ~ 85%RH		
Unit Weight	1.3g	4.2g	3.8g

AD 1 0 5 - I
 ① ② ③ ④ ⑤

Classification	Ordering Information					Description
	①	②	③	④	⑤	
Model	AD					Autonics Digital Switch
Mounting Size		1				16.5mm height
Display Range			0			0~9
Pattern				5		Standard pattern
Case Color					I	IVORY
					B	BLACK

※ Additional display range can be ordered separately

Digital Switches(Small)



Model	AD105-I
	AD105-B

※ Color : I, B



- Space-saving design
- Life cycle is greater than 30,000 operations

<Output Code Number>

Model	AD105-I AD105-B	COM("C") Contact Condition				COM
		1	2	4	8	
Preset Position	0					•
	1	•				•
	2		•			•
	3	•	•			•
	4			•		•
	5	•		•		•
	6		•	•		•
	7	•		•		•
	8				•	•
	9	•				•

Number of Switches(n)	Unit:mm		
	Size A (n×6+8)	Size B (n×6+6)	Size C
1	14	12	12.5
2	20	18	18.5
3	26	24	24.5
4	32	30	30.5
5	38	36	36.5
6	44	42	42.5
7	50	48	48.5
8	56	54	54.5
9	62	60	60.5
10	68	66	66.5

※ Includes both side covers

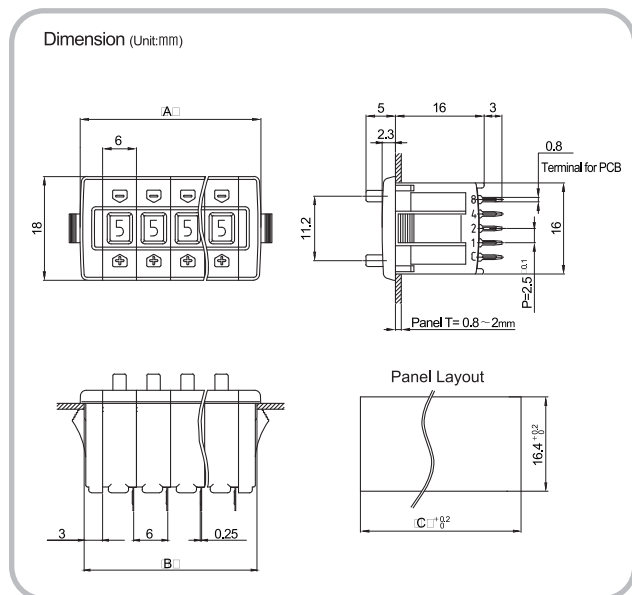

AD 6 0 5 - I
 ① ② ③ ④ ⑤

Classification	Ordering Information					Description
	①	②	③	④	⑤	
Model	AD					Autonics Digital Switch
Mounting Size		6				22.5mm height
Display Range			0			0~9
Pattern				4		Relay pattern
				5		Standard pattern
Case Color					I	IVORY
					B	BLACK

※ Additional display range can be ordered separately

Digital Switches(Standard)



Model	AD604-I	AD605-I
		AD604-B

※ Color : I, B



- One touch mounting type for easy installation
- Visibility is increased by using wide display part

AD604 Series	AD605 Series
Relay Pattern	Standard Pattern

<Output Code Number>

Model	AD604-I AD604-B AD605-I AD605-B	COM("C") Contact Condition				C O M	Number of Switches(n)	Size A (n×8+8)	Size B (n×8+6)	Size C
		1	2	4	8					
Preset Position	0					•	1	16	14	14.5
	1	•				•	2	24	22	22.5
	2		•			•	3	32	30	30.5
	3	•	•			•	4	40	38	38.5
	4			•		•	5	48	46	46.5
	5	•			•	•	6	56	54	54.5
	6		•	•		•	7	64	62	62.5
	7	•	•	•		•	8	72	70	70.5
	8				•	•	9	80	78	78.5
	9	•				•	10	88	86	86.5

※ Includes both side covers

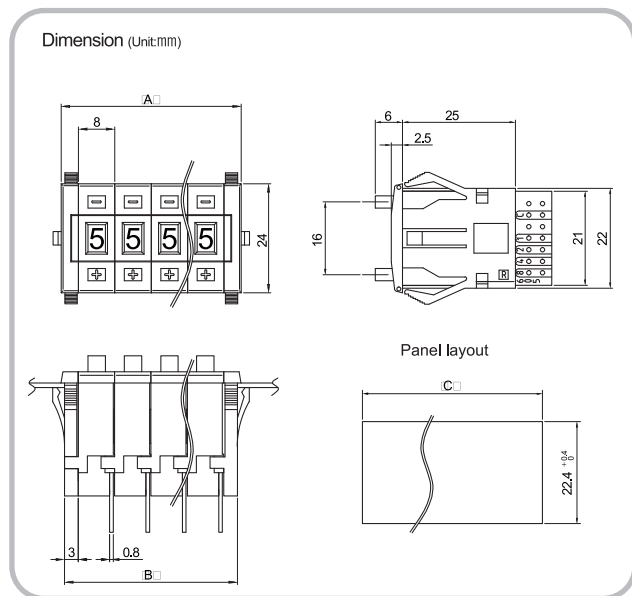

Push Button Switches

Push Button Switches (Illuminated)

Selector Switches

Double Push Button Switches

Start Push Button Switches

Emergency Switches

Emergency Switches (Illuminated)

Pilot Lamps

Accessories

Magnetic Buzzers

Piezo Buzzers

Sockets

Digital Switches

Digital Switches Accessory

AD105 - L I
 ① ② ③

Classification	Ordering Information			Description
	①	-	② ③	
Model	AD105			AD105 Series
Cover			L	Left cover
			R	Right cover
Color			I	IVORY
			B	BLACK

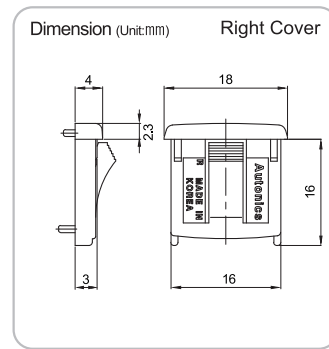
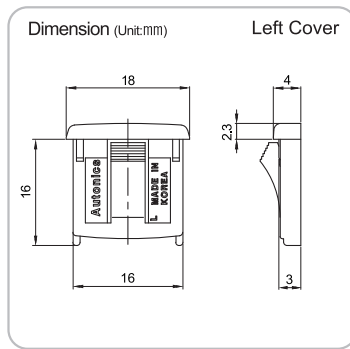

AD605 - L I
 ① ② ③

Classification	Ordering Information			Description
	①	-	② ③	
Model	AD605			AD605 Series
Cover			L	Left cover
			R	Right cover
Color			I	IVORY
			B	BLACK

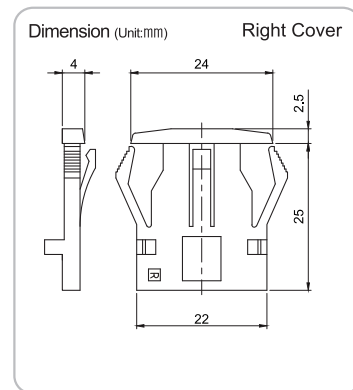
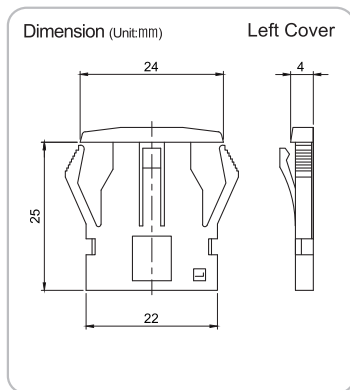

Dreaming **ORANGE** World through **Autonics ORANGE** Solution

ORANGE solution by Autonics

Orange is the corporate color of Autonics, and also implies unique IA solutions offered by Autonics. Autonics ORANGE solutions is a New and Advanced, Revolutionary and Economical sensing and control equipment offering the Optimized IA solution to the Global customers around the world.

Global partner for Industrial Automation

Autonics Corporation

Distributor

■ Major products

• Proximity sensors • Photoelectric sensors • Area sensors • Fiber optic sensors • Door/Door side sensors • Pressure sensors • Rotary encoders • Temperature controllers • Graphic/Logic panels • Field network devices • Counters • Timers • Temperature/Humidity transducers • Power controllers • Panel meters • Tachometer/Pulse(Rate) meters • Display units • Sensor controllers • Switching power supplies • Control switches/Lamps/Buzzers/Sockets • 2/5-phase stepping motors/ drivers • Motion controllers • Laser marking system(CO₂, Nd:YAG) • Laser welding/soldering system

■ Any proposal for a product improvement and development: Product@autonics.com

◎ Headquarters

41-5, Yongdang-dong, Yangsan-si, Gyeongnam, 626-847, Korea

▣ Overseas Business Dept.

Bldg. 402 3rd Fl., Bucheon Techno Park, 193, Yakdae-dong, Wonmi-gu, Bucheon-si, Gyeonggi-do, 420-734, Korea

Tel : 82-32-610-2730 / Fax : 82-32-329-0728 / E-mail : sales@autonics.com

■ Brazil

Autonics do Brasil Comercial Importadora Exportadora Ltda

Tel : 55-11-3055-1660 / Fax : 55-11-3055-1661 / E-mail : vendas@autonics.com.br

■ China

Autonics electronic(Jiaying) Corporation

Tel : 86-573-8216-1900 / Fax : 86-573-8216-1917 / E-mail : china@autonics.com

■ India

Autonics Automation India Pvt. Ltd.

Tel : 91-22-2781-4305 / Fax : 91-22-2781-4518 / E-mail : india@autonics.com

■ Indonesia

PT. Autonics Indonesia

Tel : 62-21-6586-6740 / Fax : 62-21-6586-6741 / E-mail : indonesia@autonics.com

■ Japan

Autonics Japan Corporation

Tel : 81-3-5730-0568 / Fax : 81-3-5730-0569 / E-mail : ja@autonicsjp.co.jp

■ Malaysia

Mal-Autonics Sensor Sdn. Bhd.

Tel : 60-3-7805-7190(Hunting) / Fax : 60-3-7805-7193 / E-mail : malaysia@autonics.com

■ Mexico

Autonics Mexico Sales Office

Tel : 52-55-5207-0019 / Fax : 52-55-5207-0099 / E-mail : ventas@autonics.com

■ Russia

Autonics Corp. Russia Representative Office

Tel/Fax : Tel/Fax : 7-495-933-56-18 E-mail : russia@autonics.com

■ Turkey

Autonics Otomasyon Ticaret Ltd. Sti.

Tel : 90-216-365-9117(9113, 9114) / Fax : 90-216-365-9112 / E-mail : info@autonics.com.tr

■ USA

Autonics USA, Inc.

Tel : 1-847-680-8160 / Fax : 1-847-680-8155 / E-mail : sales@autonicsusa.net

■ Vietnam

Autonics Vietnam Corp.

Tel : 84-8-3925-6563 / Fax : 84-8-3925-6564 / E-mail : vietnam@autonics.com